

An introduction to

NATIONAL CLASSIFICATION OF OCCUPATIONS- 2015



Directorate General of Employment
Ministry of Labour and Employment

WHAT IS NATIONAL CLASSIFICATION OF OCCUPATION (NCO)?

NCO is a classification of occupation which describes and assigns codes to various occupations in India as per the developments in the labour market system.

It is a compendium for occupational information available in the Indian economy.

The Directorate General of Employment, Ministry of Labour & Employment, Government of India is responsible for maintaining and updating the National Classification of Occupation in India

HISTORY OF NCO-2015

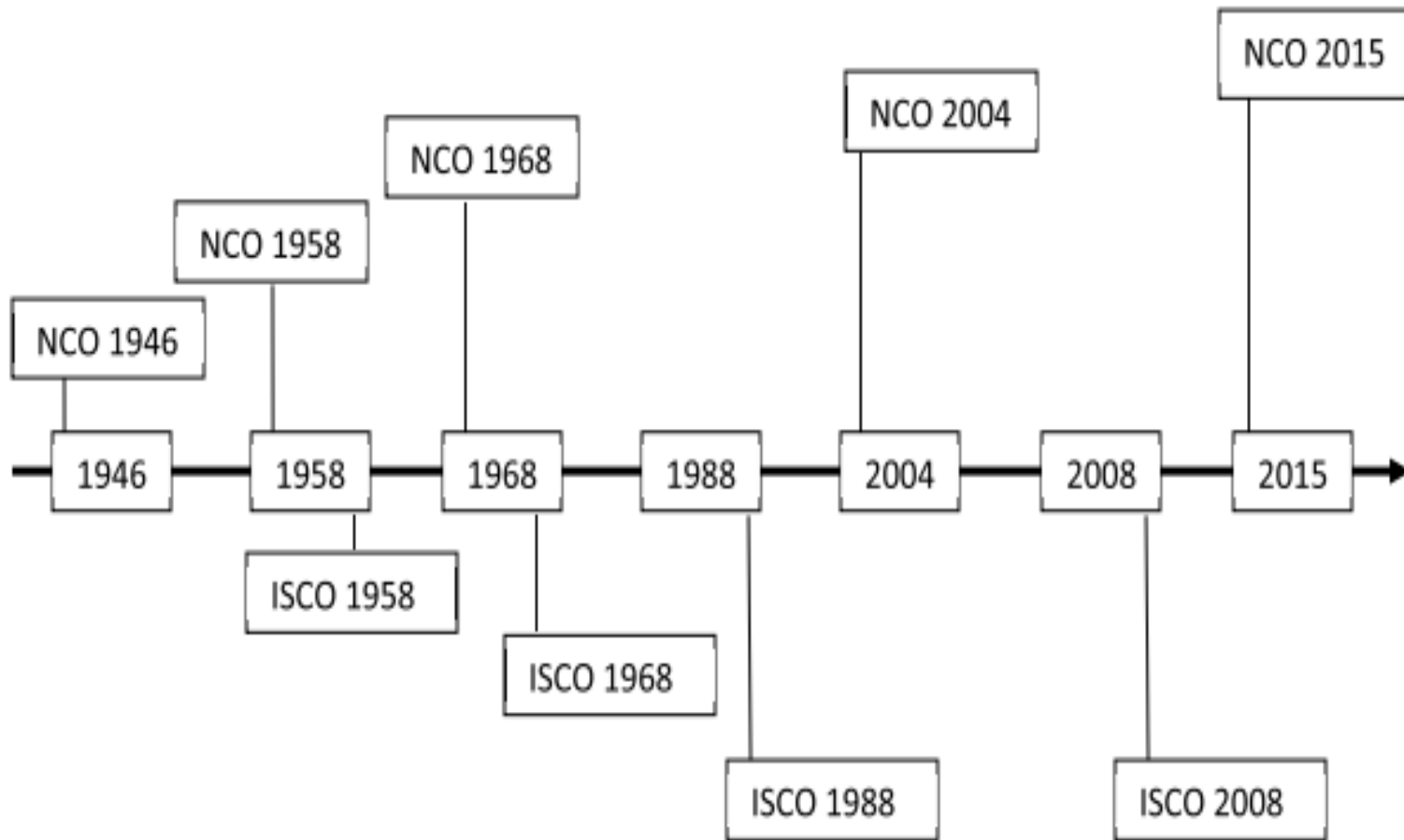

MANDATE OF NCO

- It gives an insight into the occupational framework, nature of duties involved and the level of skill requirement to perform the activities in a real time work situation.
- It plays a very vital role in maintaining standards of occupation in the country. It helps in promoting international comparability of statistical data relating to occupations.
- It is used in all types of censuses and sample surveys conducted in India especially in data collection, processing, analysis and presentation of survey results besides its wide range of applications in policy formulation and policy analysis.

NEED FOR REVISION OF NCO

Revision of content and evolving of new occupations in the Labour Market are dynamic processes

The mandate of NCO is to synchronize these activities of the Labour Market Information System across India

These codes are reviewed and updated periodically to reflect developments in the labour market, particularly with the emergence of new occupations, as well as to align with changes in the international standard to capture the structural changes in the employment market and current work practices and work environment.

NCO- 2015

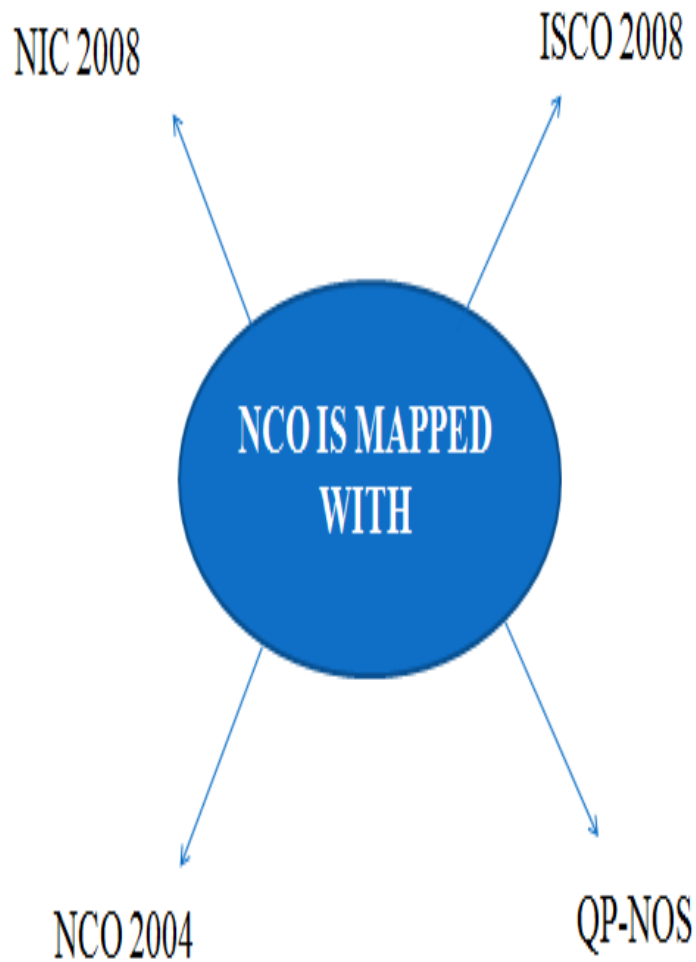

NCO 2015 is very dynamic in nature

- *Aligned to ISCO-2008*
- *Aligned with NIC*
- *Aligned with NCO 2004*
- *Aligned with QP-NOS*

3600 civilian occupations for 53 sectors, including the job descriptions for the occupations as compared to the earlier series of NCO i.e. NCO-2004, which contained the job descriptions for 2945 occupations.

Aligning NCO – 2015 to ISCO – 2008

International Labour Organization (ILO) has developed ISCO for the classification of occupations from an international perspective. The latest published version is ISCO – 2008. This classification system contains the following categories

10	Major Groups
43	Sub-Major Groups
130	Minor Groups
436	Unit Groups

ISCO – 2008 has a four digit coding structure with a single digit representation for Major Groups, Sub-Major Groups, Minor Groups, and Unit Groups

Coding Structure NCO – 2015 Digits	Representation	Corresponding Mapping to ISCO – 2008
The first digit	Division	Major Group
The first two digits	Sub-Division	Sub-Major Group
The first three digits	Group	Minor Group
The first four digits	Family	Unit Group
The first two digits after the decimal	Occupation	

Aligning NCO 2015 to NIC

NIC – 2008 coding is based on economic activities under various sectors/industries.

Currently NIC – 2008 has 21 sections (A to U) corresponding to the various sectors. All the NCO – 2015 Occupations have been classified as per sectors and mapped to NIC – 2008.

There are certain occupations that may feature in more than one sector. For example, the occupation of Storyboard Artist (NCO – 2015 Code: 2166.0209), which has QP NOS Reference of Media & Entertainment SSC - MES/Q0507, has employment prospect in multiple economic activities such as activities of individual writers for all subjects including fictional writing, technical writing, etc. (NIC 2008 Code: 90004), Publishing of computer games for all platforms (NIC 2008 Code: 58203), and Video Production (NIC 2008 Code: 59112).

Classifying the Job Roles

With time, some job codes have become irrelevant. The reason is that either the job profiles do not exist due to changing requirements of the industry or they may require certain modifications. The task involved analysis of all job codes in terms of relevance and completeness, and categorizing them in three groups namely:

- Relevant (R)
- Relevant with Modification (RM)
- Redundant/Obsolete (O)

A thorough study of all job codes was undertaken and each job code was categorised as relevant, relevant with modification, and redundant/obsolete.

STRUCTURE OF NCO CODES

An eight (8) digit coding structure. The coding structure is based on the NCO2004 coding structure with the addition of two digits (third and fourth digits after the decimal) which will be indicative QP-NOS for the job

- The 1 (first) digit : Division (Major Group)
- The first 2 (two) digits :Sub-Division (Sub-Major)
- The first 3 (three) digits :Group (Minor Group)
- The first 4 (four) digits: Family (Unit Group)
- A decimal after the first 4 (four) digits to create a distinction between the families and individual occupations
- The first 2 (two) digits after the decimal: occupation groups that can be combined under the given Family
- The last two digits of the sequence after the decimal : occupation for which QP-NOS are available.

If QP-NOS available - the last two digits after the decimal will be between 01-98 (arranged sequentially).

If QP-NOS not available - the last two digits after the decimal will remain “00”.

Code: 8153.0111

Job Title: Sewing Machine Operator, General

8	Division	In this example, '8' stands for the Division which is Plant and Machine Operators and Assemblers
---	----------	--

81	Sub-Division	81 stands for the Sub-Division of the Occupation, which is Stationary Plant and Machine Operators
----	--------------	---

815	Group	815 represents the Group under which the occupation
-----	-------	---

		falls, which is Textiles, Fur and Leather Products Machine Operators
--	--	--

8153	Family	8153 denotes the Family under which the occupation is listed, which is Sewing Machine Operators
------	--------	---

8153.01	Occupation	.011 indicates the Occupation under the given Family, which is Sewing Machine Operator, General
---------	------------	---

8153.0111	Occupation QP NOS Reference	1 (the last digit in .0111) denotes the QP NOS reference i.e. Sewing Machine Operator published by Apparel, Made-ups & Home Furnishing
-----------	--------------------------------	--

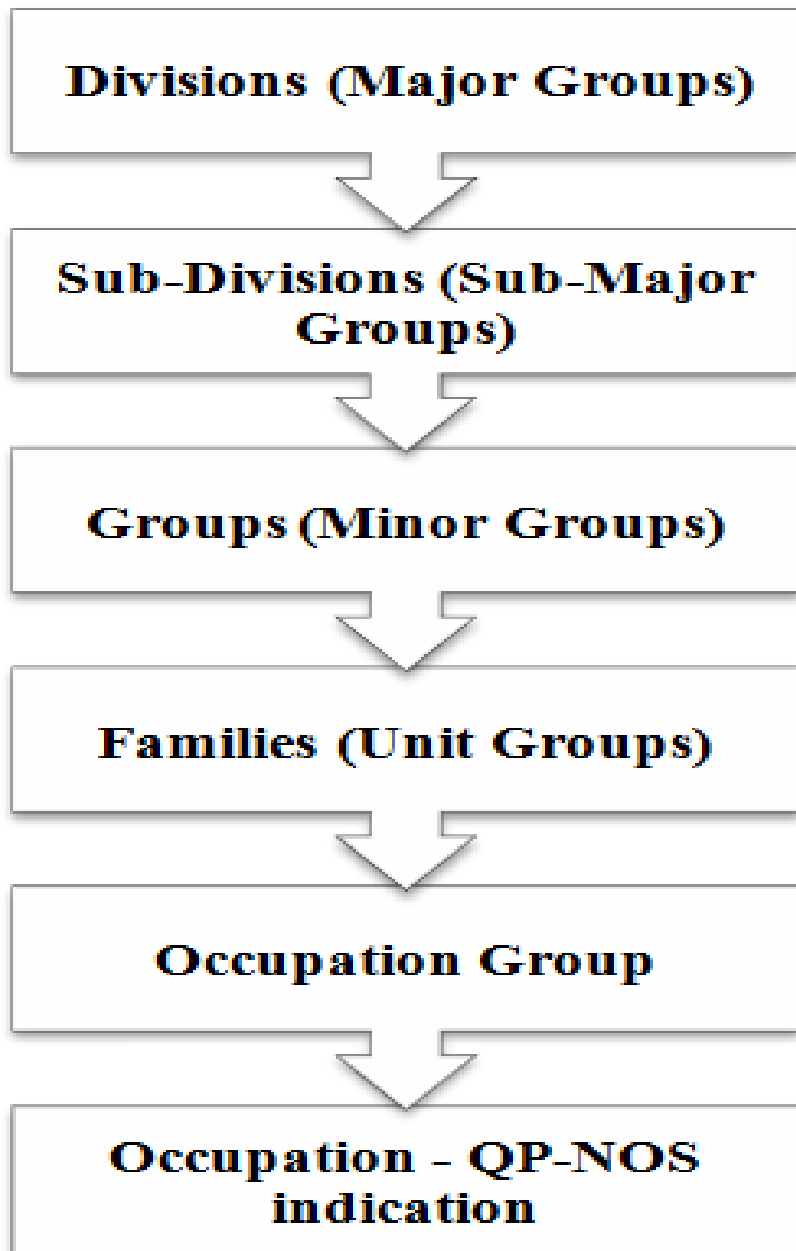

The NCO 2015 coding structure provides:

- 99 Occupational Groups under 1 Family or Unit Group
- For each Occupational Group, 98 QP/NOS references
- 9,702 QP-NOS references per Family
- Scope of adding **47,27,2800** Occupational Codes

Coding Nomenclature

NCO Coding Structure based on ISCO

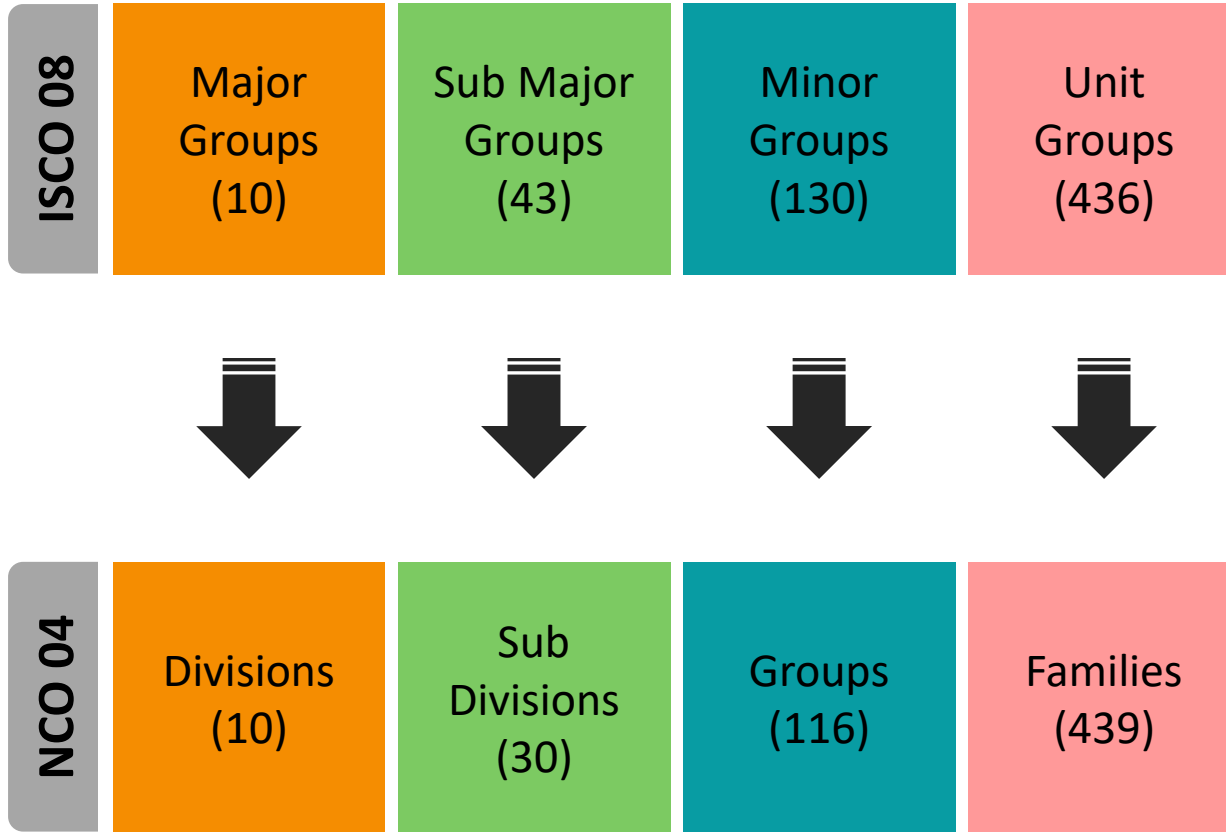

NCO Coding Structure based on ISCO

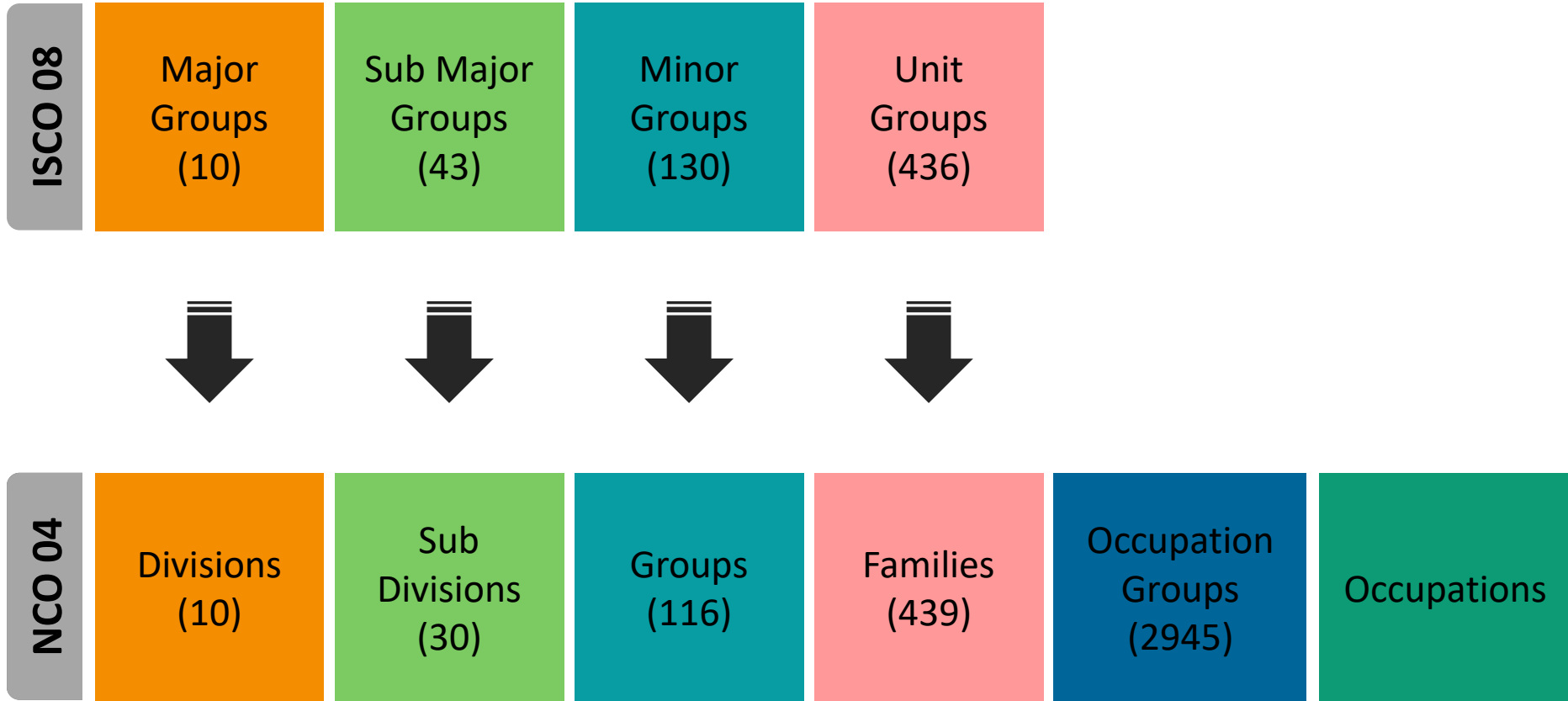

Divisions

Sub
Divisions

Groups

Families

Occupation
Groups

Occupations

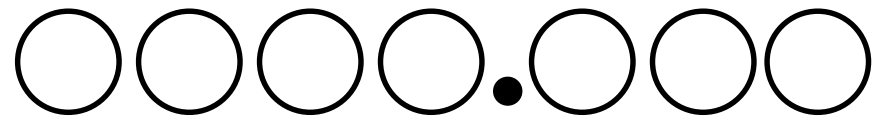

1 Legislators, Senior Officials and Managers

2 Professionals

3 Technicians and Associate Professionals

4 Clerks

5 Service Workers and Shop & Market Sales Workers

6 Skilled Agricultural and Fishery Workers

7 Craft and Related Trades Workers

8 Plant and Machine Operators and Assemblers

9 Elementary Occupations

X Workers Not Classified by Occupations

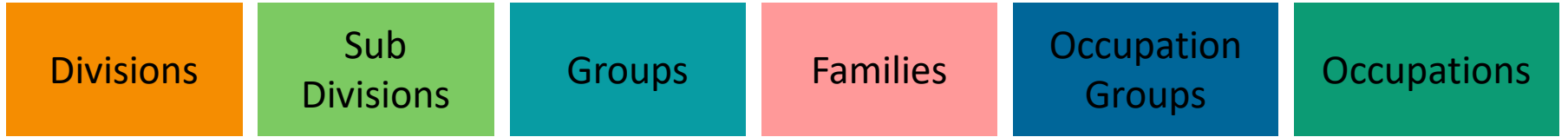

- 1 Legislators, Senior Officials and Managers
- 2 Professionals
- 3 Technicians and Associate Professionals
- 4 Clerks
- 5 Service Workers and Shop & Market Sales Workers
- 6 Skilled Agricultural and Fishery Workers
- 7 Craft and Related Trades Workers
- 8 Plant and Machine Operators and Assemblers
- 9 Elementary Occupations
- X Workers Not Classified by Occupations

Plant and machine operators and assemblers operate and monitor industrial and agricultural machinery and equipment on the spot or by remote control, drive and operate trains, motor vehicles and mobile machinery and equipment, or assemble products from component parts according to strict specifications and procedures.

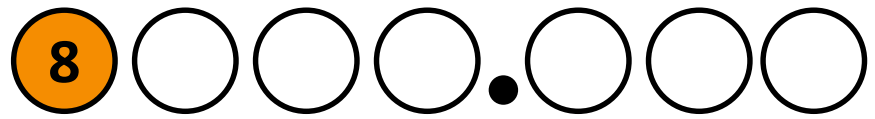

81 Stationary Plant and Related Operators

82 Machine Operators and Assemblers

83 Drivers and Mobile Plant Operators

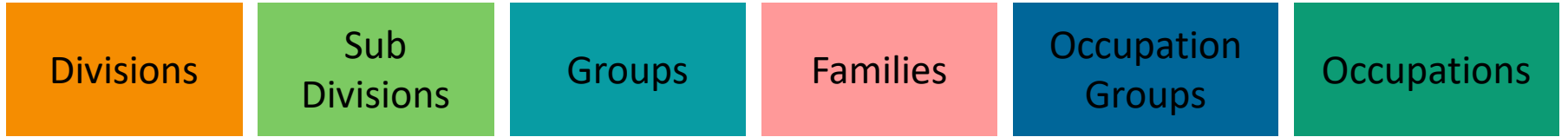
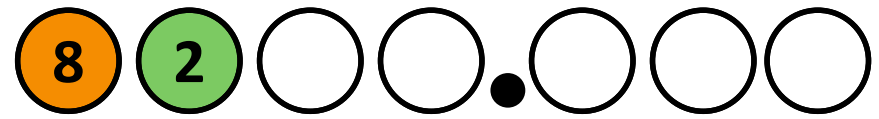

81 Stationary Plant and Related Operators

82 Machine Operators and Assemblers

83 Drivers and Mobile Plant Operators

Machine operators and assemblers operate and monitor industrial machines, on the spot or by remote control, or they assemble products from parts according to strict specifications and procedures.

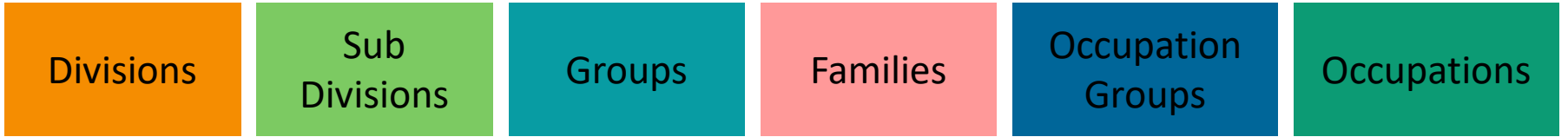

821 Metal and Mineral Products Machine Operators

822 Chemical Products Machine Operators

823 Rubber and Plastic Products Machine Operators

824 Wood Products Machine Operators

825 Printing, Binding and Paper Products Machine Operators

826 Textiles, Fur and Leather Products Machine Operators

827 Food and Related Products Machine Operators

828 Assemblers

829 Other Machine Operators and Assemblers

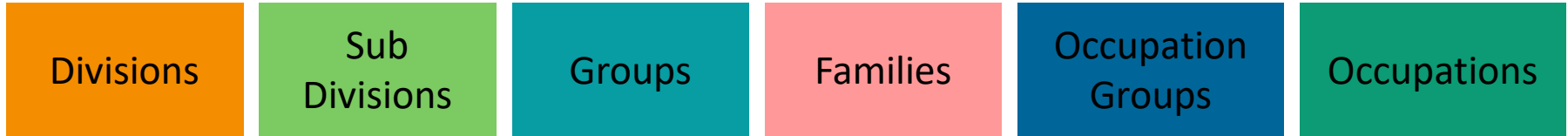

- 821 Metal and Mineral Products Machine Operators
- 822 Chemical Products Machine Operators
- 823 Rubber and Plastic Products Machine Operators
- 824 Wood Products Machine Operators
- 825 Printing, Binding and Paper Products Machine Operators
- 826 Textiles, Fur and Leather Products Machine Operators**
- 827 Food and Related Products Machine Operators
- 828 Assemblers
- 829 Other Machine Operators and Assemblers

Textiles, fur and leather products machine operators operate and monitor machines which prepare fibres and yarns, or hides and pelts, and manufacture or dry-clean textiles, or fur and leather articles.



- 8261 Fibre Preparing, Spinning and Winding Machine Operators
- 8262 Weaving and Knitting Machine Operators
- 8263 Sewing Machine Operators
- 8264 Bleaching, Dyeing and Cleaning Machine Operators
- 8265 Fur and Leather Preparing Machine Operators
- 8266 Shoe Making and Related Machine Operators
- 8268 Supervisors and Foremen, Spinning, Weaving,, Knitting, Dyeing and Related Processes
- 8269 Textile, Fur and Leather Products Machine Operators, not elsewhere classified

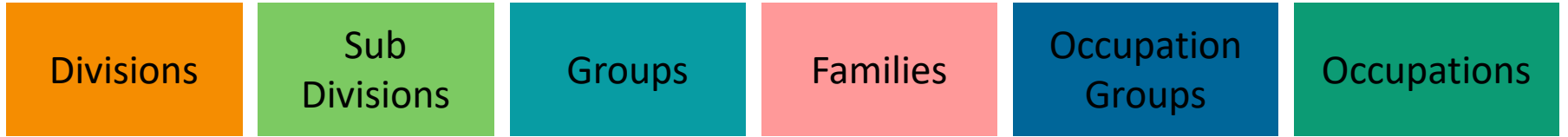

- 8261 Fibre Preparing, Spinning and Winding Machine Operators
- 8262 Weaving and Knitting Machine Operators
- 8263 Sewing Machine Operators
- 8264 Bleaching, Dyeing and Cleaning Machine Operators
- 8265 Fur and Leather Preparing Machine Operators
- 8266 Shoe Making and Related Machine Operators
- 8268 Supervisors and Foremen, Spinning, Weaving,, Knitting, Dyeing and Related Processes
- 8269 Textile, Fur and Leather Products Machine Operators, not elsewhere classified

Sewing machine operators operate and monitor sewing machines to make textile, fur or leather garments or embroider ornamental designs on garments or other materials.

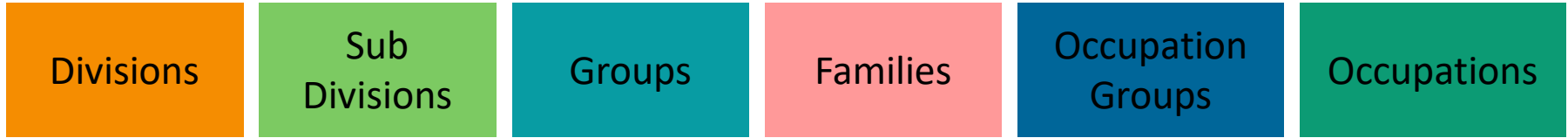

- 8263.01 Sewing Machine Operator, General
- 8263.02 Button Hole Maker, Machine
- 8263.03 Eyelet Holing Machine Operator
- 8263.04 Button Stitching Machine Operator
- 8263.05 Embroider, Machine
- 8263.06 Embroidery- Machine Operator (Semi Automatic)

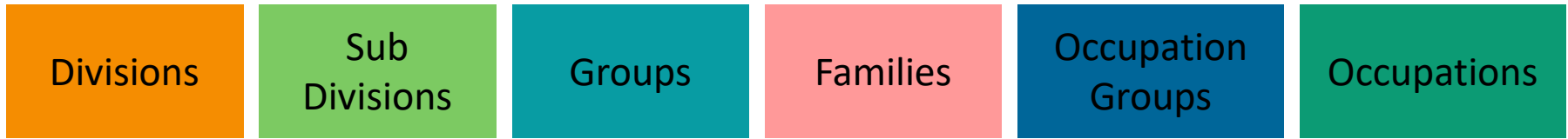

8263.01 Sewing Machine Operator, General

8263.02 Button Hole Maker, Machine

8263.03 Eyelet Holing Machine Operator

8263.04 Button Stitching Machine Operator

8263.05 Embroider, Machine

8263.06 Embroidery- Machine Operator (Semi Automatic)

Operates sewing machine to join pieces of cloth, hosiery fabric, canvas, fur and leather for making garments, bags, upholstery and other textile and fur products.

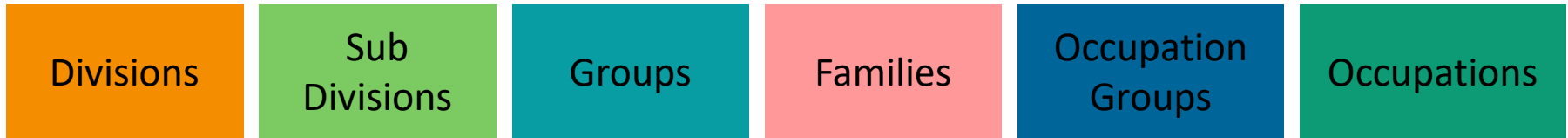

- 8263.011 Sewing Machine Operator, General
- 8263.020 Button Hole Maker, Machine
- 8263.030 Eyelet Holing Machine Operator
- 8263.040 Button Stitching Machine Operator
- 8263.050 Embroider, Machine
- 8263.060 Embroidery- Machine Operator (Semi Automatic)

Qualification Pack AMH/Q0301: Sewing Machine Operator

A Sewing Machine Operator, also called a ‘Stitcher or Machinist’ is an important job-role associated with Apparel sector. The primary responsibility of a machinist is to stitch/ sew fabric, fur, or synthetic materials to produce apparels.

Divisions	Sub Divisions	Groups	Families	Occupation Groups	Occupations
8					Plant And Machine Operators and Assemblers
8	2				Machine Operators and Assemblers
8	2	6			Textiles, Fur and Leather Products Machine Operators
8	2	6	3		Sewing Machine Operators
8	2	6	3	0 1	Sewing Machine Operator, General
8	2	6	3	0 1 1	Sewing Machine Operator (QP AMH/Q0301)

ROLE OF NSDC/MSDE

All the QPs released by the various sector/industries through NSDC are mapped to the job roles in the NCO – 2015. Thus, all the QPs released by the various SSCs are mapped and added during the creation of NCO – 2015.

A QP NOS in the NCO – 2015 is aligned to a job role wherever an exact match is found.

A new job role is added to the NCO where there is no description of a job role specified as per a given QP NOS. The NCO – 2015 would be updated as and when new QPs are released by the SSCs.

THANK YOU